

INSTRUCTION MANUAL

HACKNEY

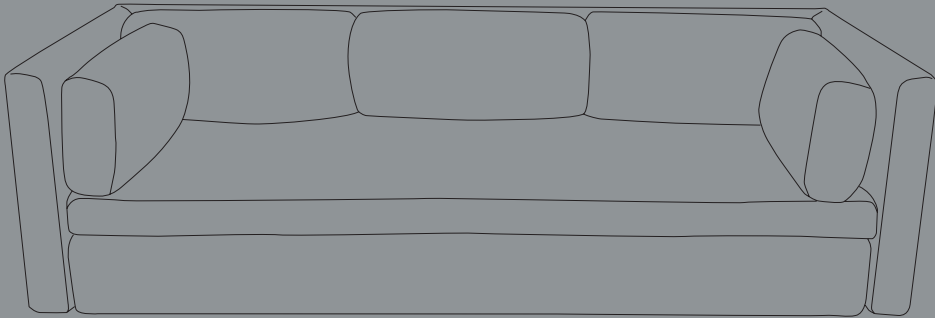

By *HAY*

HAY

INTRODUCTION

With its contemporary lines and high comfort, the Hackney Sofa strikes the perfect balance between modern and traditional styling.

Constructed with a wooden frame featuring a coil spring system wrapped in down and polyurethane foam, it offers soft and comfortable seating. Its generous proportions and timeless aesthetics make it suitable for a wide range of private and public contexts.

Available in 2-seater or 3-seater versions in a variety of upholstery options.

CARE AND MAINTENANCE

CAUTION

With a little care you can prolong the life of your furniture. Follow the instructions for the materials of your specific product to make sure that it stays in the best shape for as long as possible.

The information below is only intended as a general guideline. For more information on how to remove specific stains, please enquire where you bought the furniture.

- Always remove stains quickly before they can do any permanent damage to the furniture.
- Avoid placing the furniture in direct sunlight or near a strong heat source to reduce changes. HAY only uses top-quality fabrics but all fabrics fade, and seams weaken, when exposed to sunlight or strong heat.
- When you move your furniture, make sure you lift it rather than pulling or pushing it to avoid damaging the floor, legs and mountings.
- The sofa is heavy, so please be careful when moving it, as moving and lifting heavy goods can cause injury. We recommend that four people assist with moving the whole sofa, and two people with moving the individual sections (seat base and backrest/armrest).
- Avoid improper use such as sitting on the back or armrests, putting your feet on the furniture or standing on the it.
- Be careful not to scratch or damage the surface with sharp objects.
- Smooth out creases and wrinkles with your hand after use to even out the fabric and prevent seam lines from becoming skewed.
- Turn the cushions over regularly to avoid patinating on one side only.
- Plump the cushions and mattress regularly to maintain the shape.

CARE AND MAINTENANCE

FABRICS

- Vacuum the furniture regularly using the upholstery nozzle to remove dust and avoid fluff and pilling.
- Straighten the fabric with your hands from time to time. Wrinkles in the fabric can be straightened using a steamer.
- Soak up spilled liquids immediately with an absorbent napkin or cloth by dabbing gently towards the centre of the stain.
- Never use concentrated detergents or bleach, ammonia, optical brighteners or soap intended for hard surfaces.
- We do not recommend spot cleaning of individual marks and stains as this damages the fabric and causes colour loss.
- On wool fabrics, most stains can be removed with lukewarm water on a clean lint-free cloth. If necessary, add a little neutral detergent. Avoid rubbing the material hard as this could result in loss of colour and damage the fabric. It may also be necessary to use a hairdryer to avoid leaving a water outline. If the stain persists, consult a specialist cleaner.

VELOUR

- Vacuum the furniture regularly using the upholstery nozzle /or brushing with a soft clothes brush – always in the direction of the nap to remove dust and avoid fluff and pilling.
- To rejuvenate velour and restore its pile, rub it with a well wrung, slightly damp cloth in the direction of the nap.
- When you sit on velour fabric, you exert a pressure that forces the nap in different directions. Together with heat, rising air humidity, body moisture and the type of upholstery, this can cause these changes of direction to become fixed, creating a slight change in colour. This is a typical property of velour, and is neither a defect nor a sign of low quality. This effect can be removed by applying a damp (not wet) cloth and leaving it overnight, which will restore the pile to its original direction. The upholstered furniture should not be used until it is completely dry. If necessary, a hair dryer can be used at a low temperature setting.
- The same result can be achieved by steaming or spraying distilled water at a distance of 20 cm from the fabric for a few seconds, before leaving overnight. Care should be taken not to spill large quantities of water on the fabric. It is advisable to treat the whole surface in order to avoid shading. This treatment can be repeated if necessary. After this treatment, the upholstered furniture must be completely dry before it can be used again. A hair dryer at a low temperature setting can be used. To restore the pile to its original direction, please brush with a soft brush.

CARE AND MAINTENANCE

ANILINE LEATHER

- Aniline leather has no or only a light surface treatment to preserve the leather's natural surface and soft touch.
- All natural markings, such as scars and insect bites, will be visible on aniline leather, which contributes to the leather's exclusive appearance.
- This kind of leather is very susceptible to dirt, and over time it will patinate and become slightly darker. Be careful not to scratch the leather.
- Aniline leather is demanding to maintain, and we recommend that you keep a cleaner and care product suitable for this type of leather at hand. Using water may leave a permanent stain on the surface.
- Do not use sharp objects, strong detergents or solvents on the leather.

SEMI-ANILINE LEATHER

- Semi-aniline leather is a full grain leather with a light top finish.
- All natural markings, such as scars and insect bites, will be visible on the leather.
- Vacuum regularly using the upholstery nozzle. Be careful not to scratch the leather.
- To remove stains, use a clean, lint-free cloth to apply the leather from a solution of water and a neutral detergent or soap flakes or use a special leather care product. Remove soap residue immediately using a clean, dry cloth, and polish gently, using a soft cotton cloth. Avoid pressing liquid into the pores of the leather.
- Apply a protective lotion two to four times annually to enhance the resistance of the material.
- Do not use sharp objects, strong detergents or solvents on the leather.

CARE AND MAINTENANCE

PIGMENTED LEATHER

- Pigmented leather is corrected leather with excellent durability.
- Vacuum regularly using the upholstery nozzle. Be careful not to scratch the leather.
- To remove stains, use a clean, lint-free cloth to apply the lather from a solution of water and a mild detergent, or soap flakes, or use a special leather care product. Remove soap residue immediately using a clean, dry cloth, and polish gently, using a soft cotton cloth. Avoid pressing liquid into the pores of the leather.
- Apply a protective lotion two to four times annually to enhance the resistance of the material.
- Do not use sharp objects, strong detergents or solvents on the leather.

The sofa can be dismantled into three parts – the seat, the cushions and the foldable outer frame. Please note that outer frames covered in velvet and other soft or delicate fabrics cannot be folded, as this will damage the textile

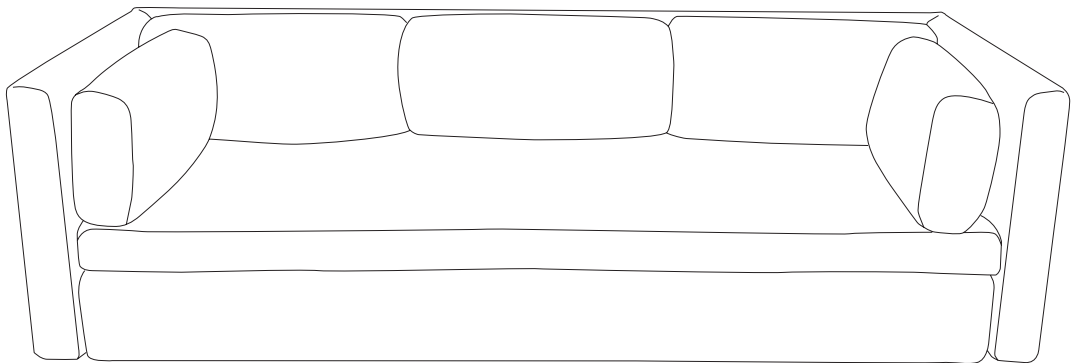

1.

Remove all cushions, including the mattress.

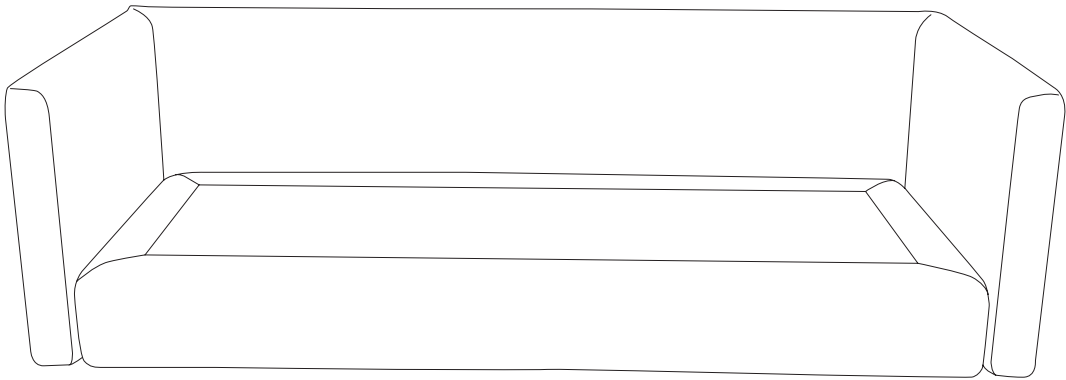

2.

Lift the end of the seat base so the metal clips unhook. Move the arms of the sofa outwards. Repeat on the other side of the seat base. **WARNING:** The sofa is heavy, so it is advisable that two or more people complete this step.

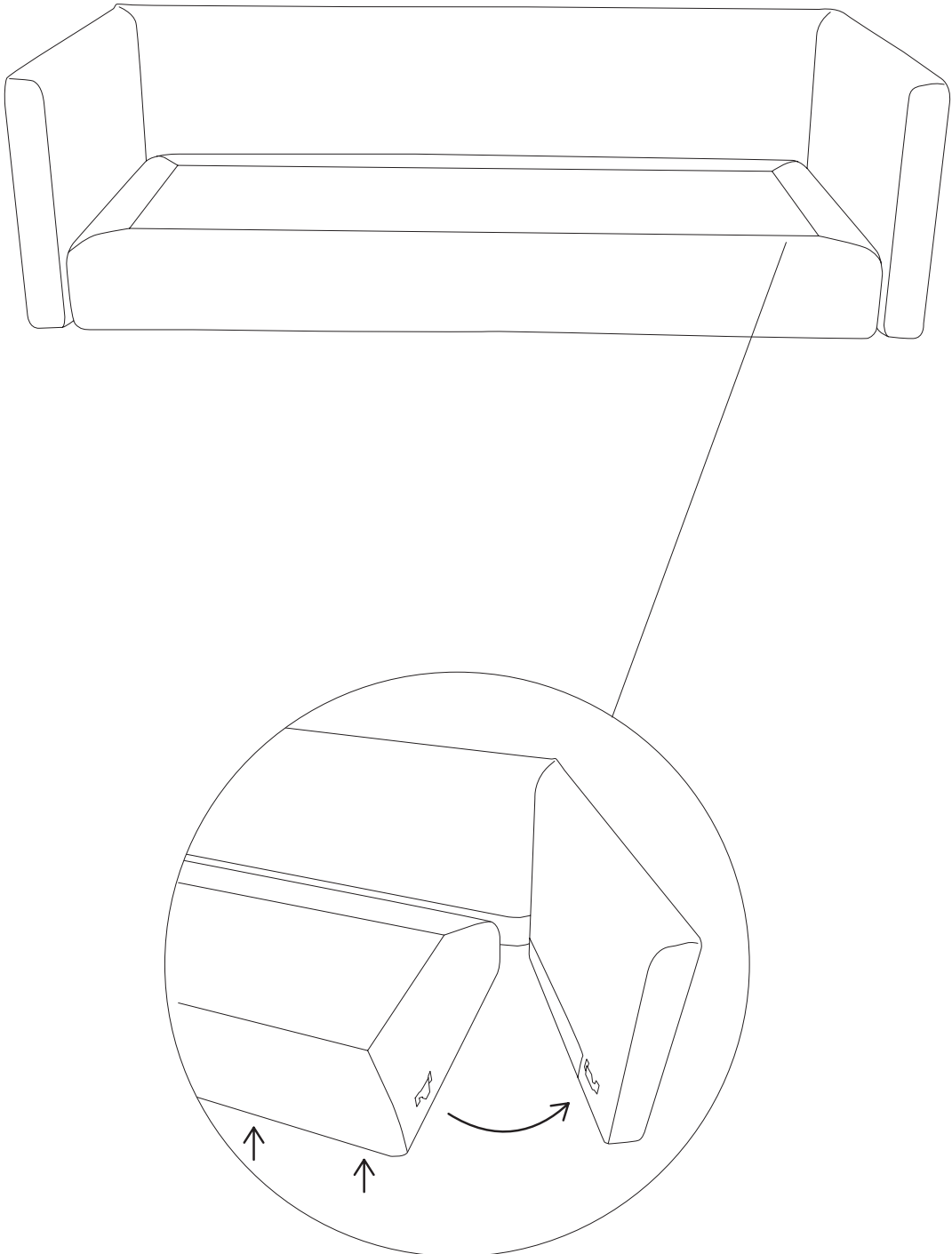

3.

Lift the seat base so that the central metal clip unhooks.

WARNING: The sofa is heavy, so it is advisable that two or more people complete this step.

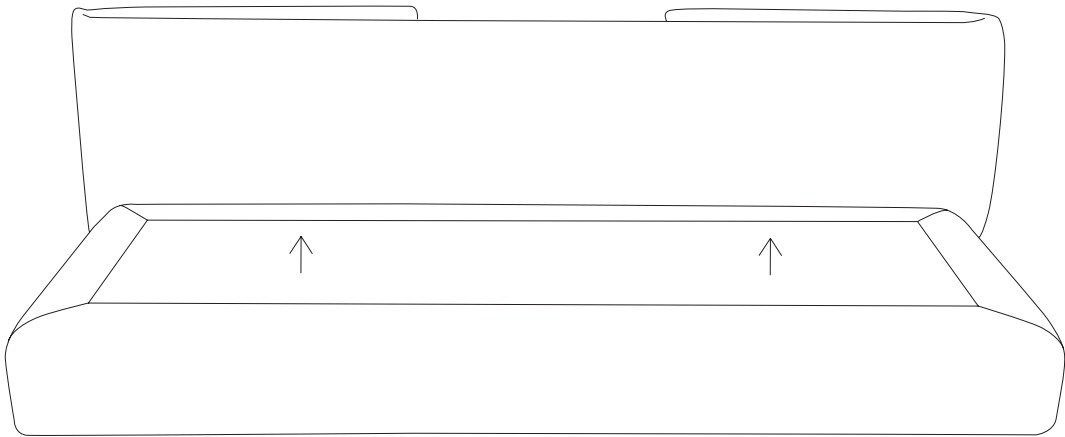

4.

You can now move the heavy sections of the sofa individually.

WARNING: The sofa is heavy, so it is advisable that two people or more complete this step.

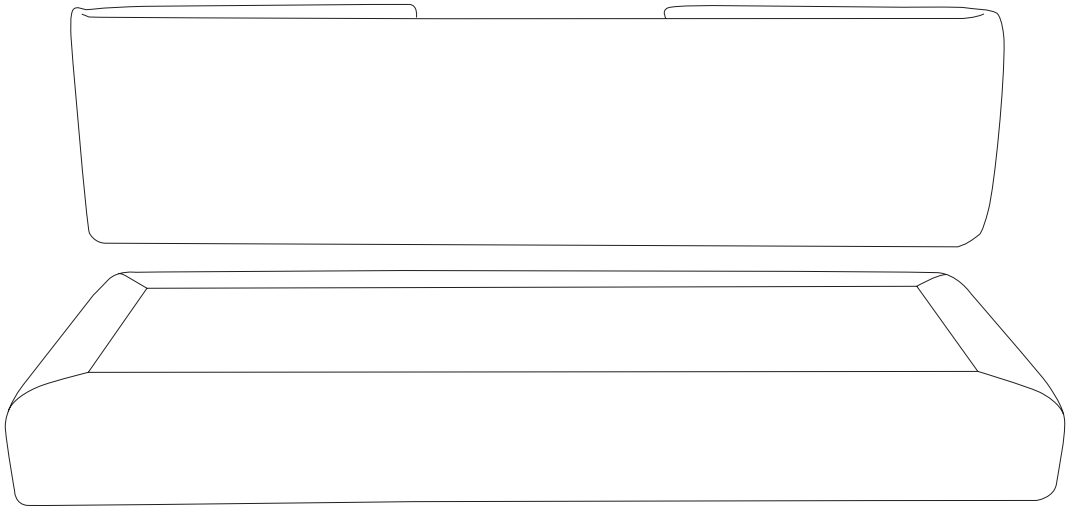

5.

To reassemble, please reverse the steps. It is important that you push any excess material in the fold joint before re-positioning to ensure a neat and tidy fold.

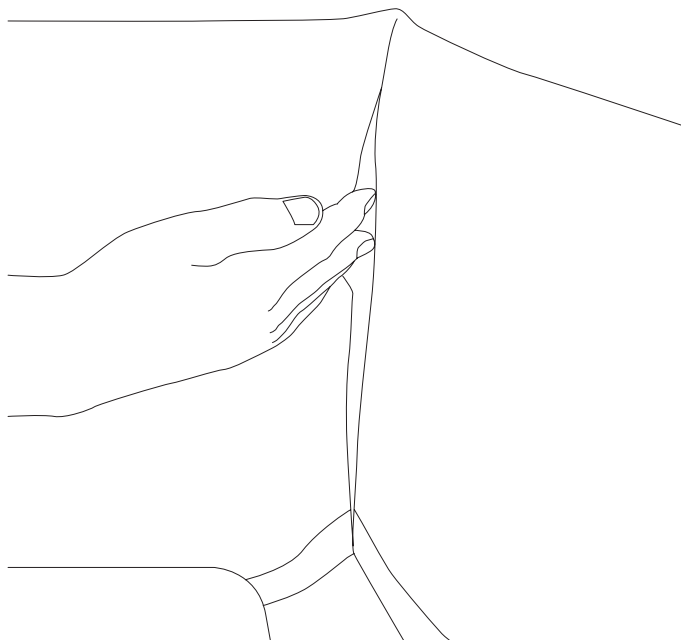

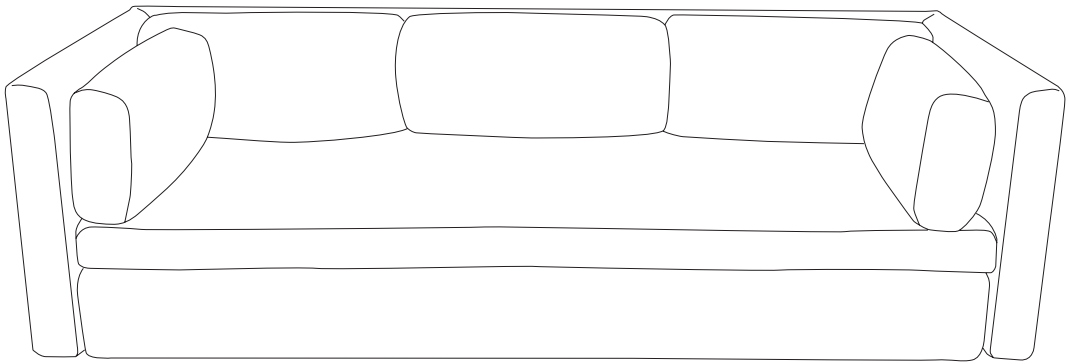

MAINTENANCE

Your sofa will need some regular attention to ensure that the cushions remain plump and the mattress keeps its shape.

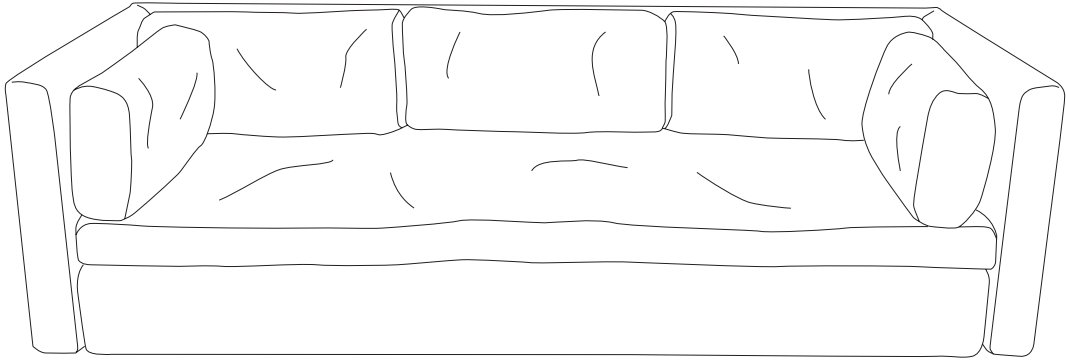

1.

Straighten out any creases and lumps in the mattress with your hands.

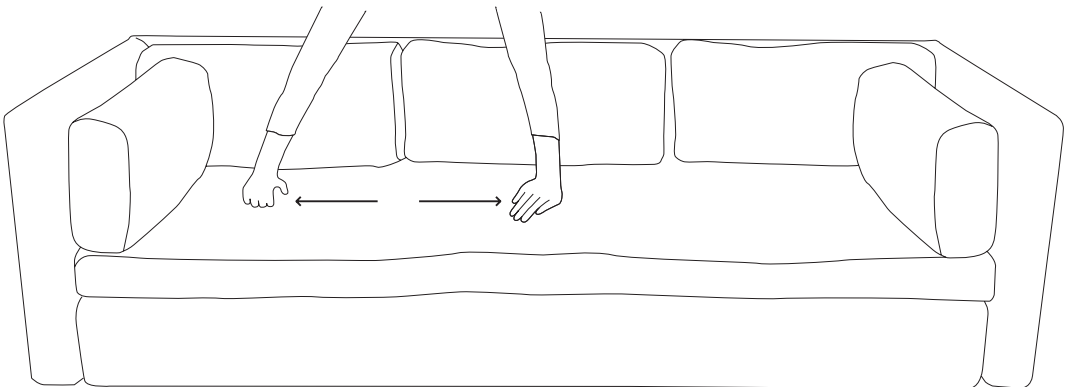

2.

Plump the individual cushions regularly.

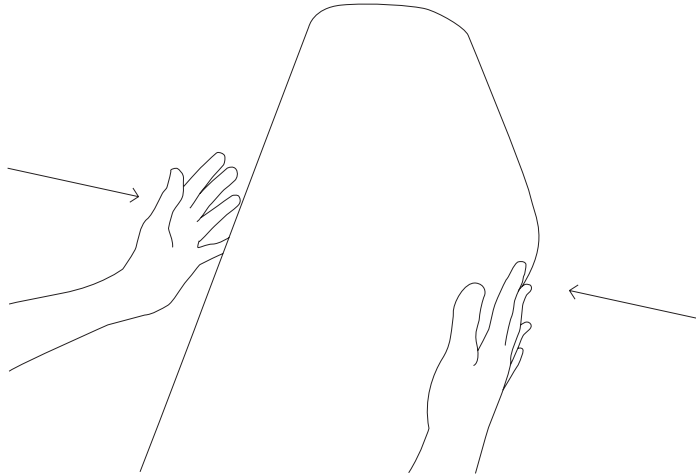

3.

Smooth out the fabric on the arm/backrest joint.

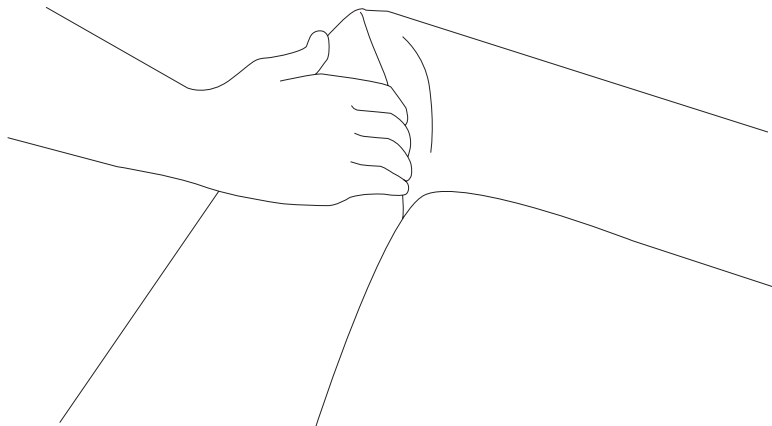

4.

Run your hands along the armrest and back to remove any creases.



5.

With regular attention and care, your sofa will keep its shape and stay comfortable for longer.

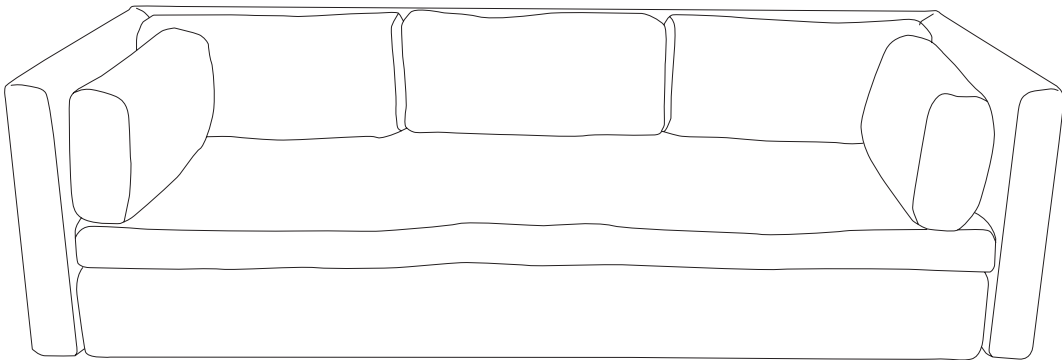

Havnen 1 8700 Horsens Denmark
+45 4282 0282 / hay@hay.com

HAY

ITEM NO. 706316

